

SOP-8L Plastic-Encapsulate MOSFETS

LJ4828

60V Dual N-Channel MOSFET

General Description

The LJ4828 uses advanced trench technology to provide excellent $R_{DS(ON)}$ and low gate charge. This device is suitable for use as a load switch or in PWM applications.

Features

- V_{DS} (V) = 60V
- I_D = 4.5A (V_{GS} = 10V)
- $R_{DS(ON)}$ < 80m Ω (V_{GS} = 10V)
- $R_{DS(ON)}$ < 90m Ω (V_{GS} = 4.5V)

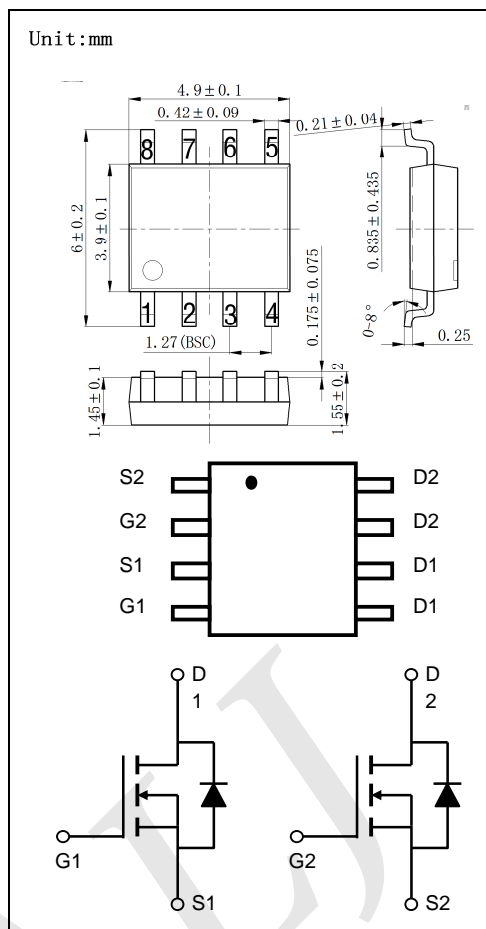

Absolute Maximum Ratings $T_A=25^\circ\text{C}$ unless otherwise noted

Symbol	Parameter	Maximum	Units
V_{DS}	Drain-Source Voltage	60	V
V_{GS}	Gate-Source Voltage	± 20	V
I_D	Continuous Drain Current ^{AF}	$T_A=25^\circ\text{C}$	4.5
		$T_A=70^\circ\text{C}$	3.6
I_{DM}	Pulsed Drain Current ^B	20	A
P_D	Power Dissipation	$T_A=25^\circ\text{C}$	2
		$T_A=70^\circ\text{C}$	1.28
I_{AR}, I_{AS}	Avalanche Current ^B	19	A
E_{AR}, E_{AS}	Repetitive avalanche energy 0.1mH ^B	18	mJ
T_J, T_{STG}	Junction and Storage Temperature Range	-55 to 150	$^\circ\text{C}$

Thermal Characteristics					
Symbol	Parameter		Typ	Max	Units
$R_{\theta JA}$	Maximum Junction-to-Ambient ^A	$t \leq 10\text{s}$	48	62.5	$^\circ\text{C/W}$
	Maximum Junction-to-Ambient ^A	Steady-State	74	110	$^\circ\text{C/W}$
$R_{\theta JL}$	Maximum Junction-to-Lead ^C	Steady-State	35	60	$^\circ\text{C/W}$

Electrical Characteristics (T_J=25°C unless otherwise noted)

Symbol	Parameter	Conditions	Min	Typ	Max	Units
STATIC PARAMETERS						
BV _{DSS}	Drain-Source Breakdown Voltage	I _D =250μA, V _{GS} =0V	60	65		V
I _{DSS}	Zero Gate Voltage Drain Current	V _{DS} =60V, V _{GS} =0V T _J =55°C			1 5	μA
I _{GSS}	Gate-Body leakage current	V _{DS} =0V, V _{GS} = ±20V			100	nA
V _{GS(th)}	Gate Threshold Voltage	V _{DS} =V _{GS} I _D =250μA	1.0	1.2	2.0	V
I _{D(ON)}	On state drain current	V _{GS} =10V, V _{DS} =5V	20			A
R _{DS(ON)}	Static Drain-Source On-Resistance	V _{GS} =10V, I _D =4.5A T _J =125°C		68 82	80 100	mΩ
		V _{GS} =4.5V, I _D =3A		77	90	mΩ
g _{FS}	Forward Transconductance	V _{DS} =5V, I _D =4.5A		11		S
V _{SD}	Diode Forward Voltage	I _S =1A, V _{GS} =0V		0.74	1.2	V
I _S	Maximum Body-Diode Continuous Current				3	A
I _{SM}	Pulsed Body Diode Current ^B				20	A
DYNAMIC PARAMETERS						
C _{iss}	Input Capacitance	V _{GS} =0V, V _{DS} =30V, f=1MHz		450	540	pF
C _{oss}	Output Capacitance			60		pF
C _{rss}	Reverse Transfer Capacitance			25		pF
R _g	Gate resistance	V _{GS} =0V, V _{DS} =0V, f=1MHz	1.3	1.65	2	Ω
SWITCHING PARAMETERS						
Q _g (10V)	Total Gate Charge	V _{GS} =10V, V _{DS} =30V, I _D =4.5A		8.5	10.5	nC
Q _g (4.5V)	Total Gate Charge			4.3	5.5	nC
Q _{gs}	Gate Source Charge			1.6		nC
Q _{gd}	Gate Drain Charge			2.2		nC
t _{D(on)}	Turn-On DelayTime	V _{GS} =10V, V _{DS} =30V, R _L =6.7Ω, R _{GEN} =3Ω		4.7		ns
t _r	Turn-On Rise Time			2.3		ns
t _{D(off)}	Turn-Off DelayTime			15.7		ns
t _f	Turn-Off Fall Time			1.9		ns
t _{rr}	Body Diode Reverse Recovery Time	I _F =4.5A, dI/dt=100A/μs		27.5	35	ns
Q _{rr}	Body Diode Reverse Recovery Charge	I _F =4.5A, dI/dt=100A/μs		32		nC

A: The value of R_{θJA} is measured with the device mounted on 1in 2 FR-4 board with 2oz. Copper, in a still air environment with T_A=25°C. The value in any given application depends on the user's specific board design.

B: Repetitive rating, pulse width limited by junction temperature.

C: The R_{θJA} is the sum of the thermal impedance from junction to lead R_{θJL} and lead to ambient.

D: The static characteristics in Figures 1 to 6 are obtained using <300 μs pulses, duty cycle 0.5% max.

E: These tests are performed with the device mounted on 1 in 2 FR-4 board with 2oz. Copper, in a still air environment with T_A=25°C. The SOA curve provides a single pulse rating.

F: The current rating is based on the t_s 10s junction to ambient thermal resistance rating.

TYPICAL ELECTRICAL AND THERMAL CHARACTERISTICS

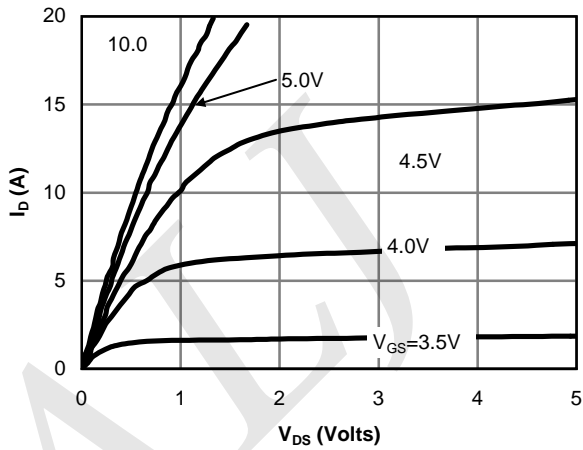

Fig 1: On-Region Characteristics

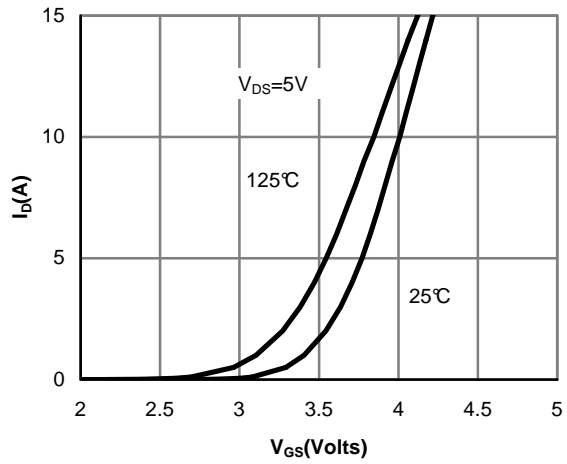

Figure 2: Transfer Characteristics

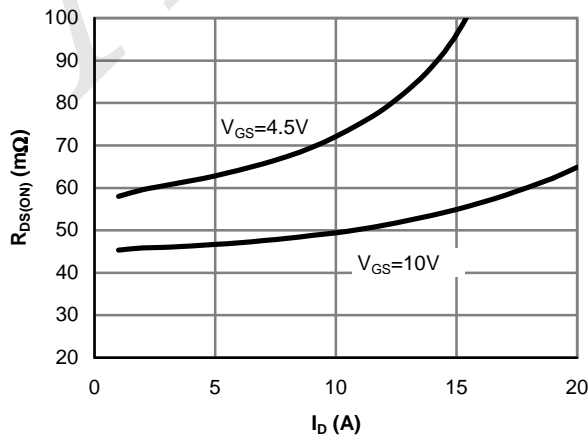

Figure 3: On-Resistance vs. Drain Current and Gate Voltage

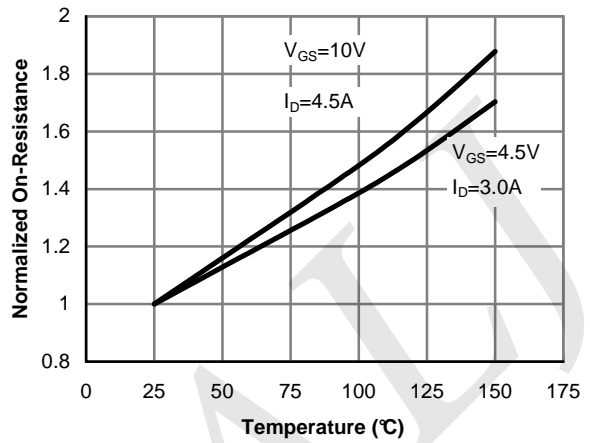

Figure 4: On-Resistance vs. Junction Temperature

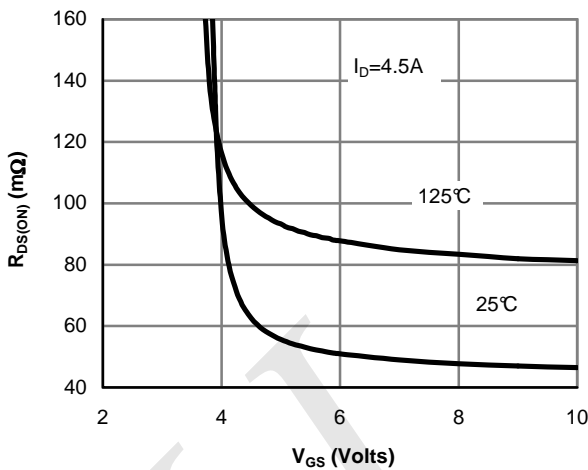

Figure 5: On-Resistance vs. Gate-Source Voltage

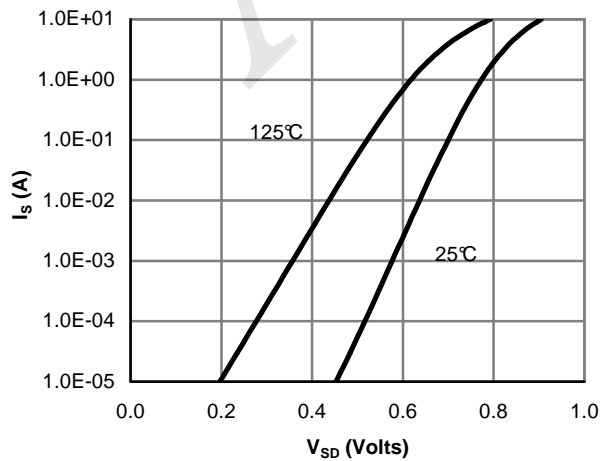

Figure 6: Body-Diode Characteristics

TYPICAL ELECTRICAL AND THERMAL CHARACTERISTICS

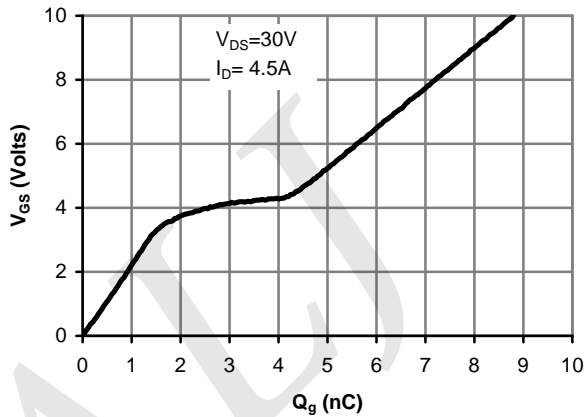

Figure 7: Gate-Charge Characteristics

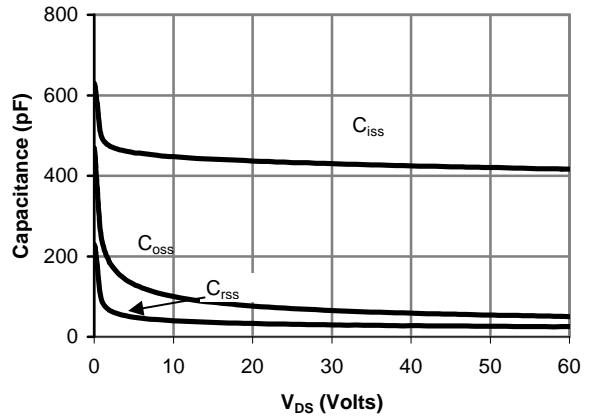

Figure 8: Capacitance Characteristics

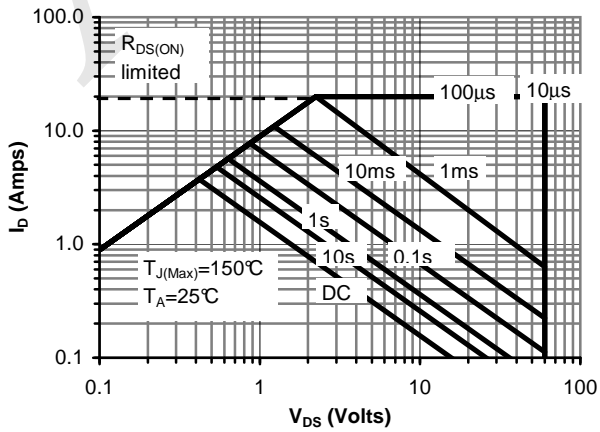

Figure 9: Maximum Forward Biased Safe Operating Area (Note E)

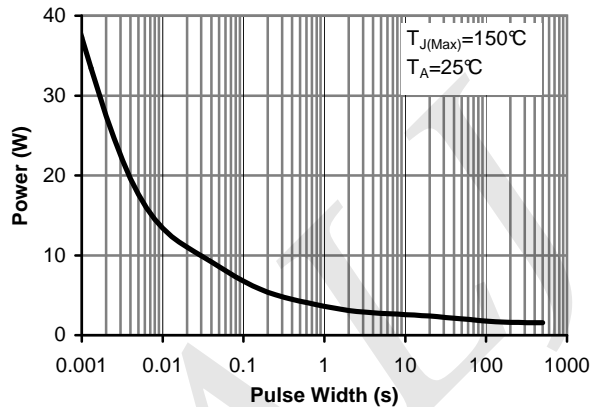

Figure 10: Single Pulse Power Rating Junction-to-Ambient (Note E)

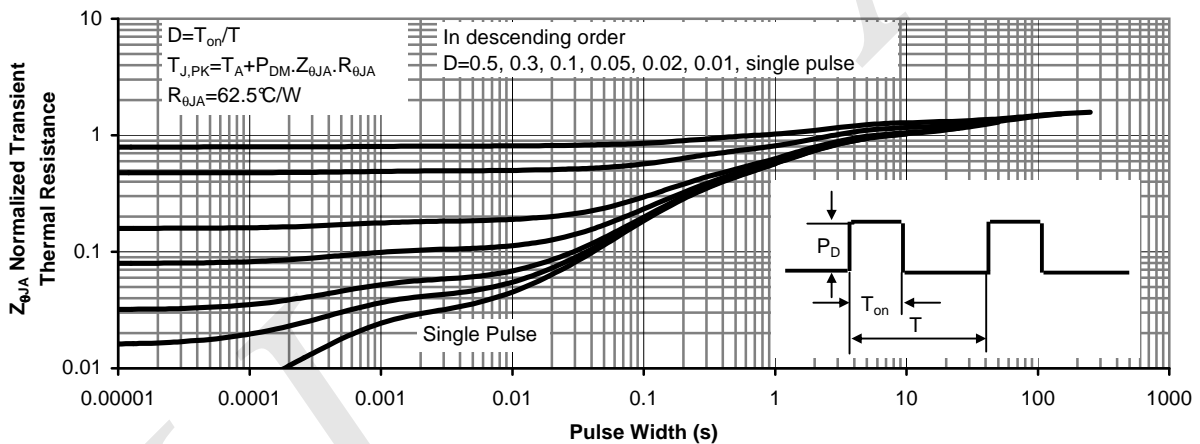
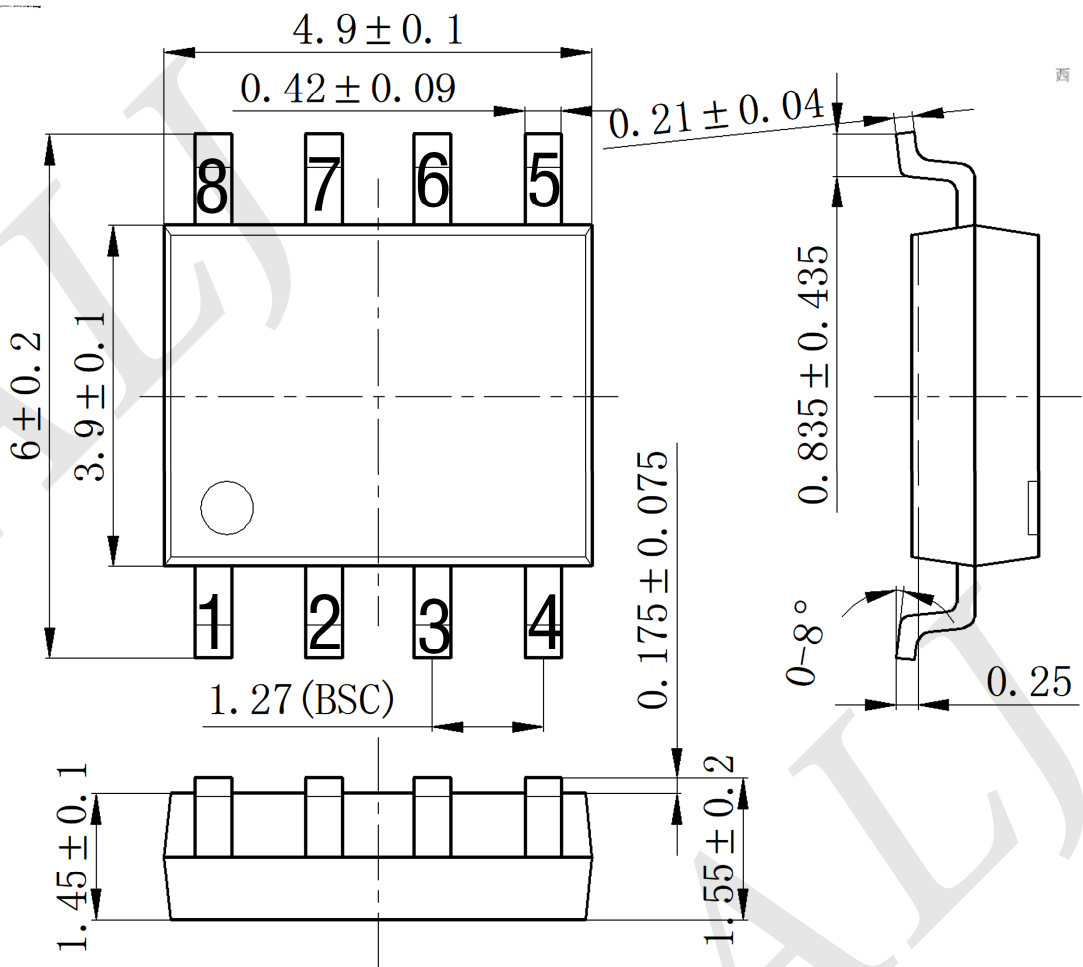
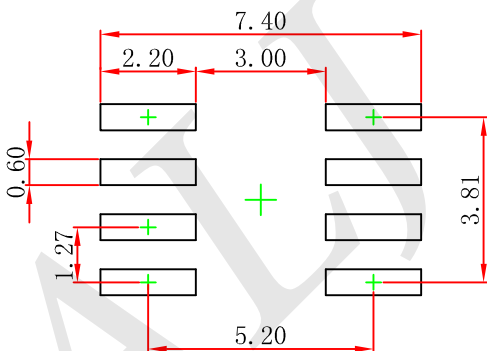

Figure 11: Normalized Maximum Transient Thermal Impedance

Unit:mm



SOP8 Suggested Pad Layout



- Note:
1. Controlling dimension: in millimeters.
 2. General tolerance: ± 0.05 mm.
 3. The pad layout is for reference purposes only.

SOP8 Tape and Reel

SOP8 Embossed Carrier Tape

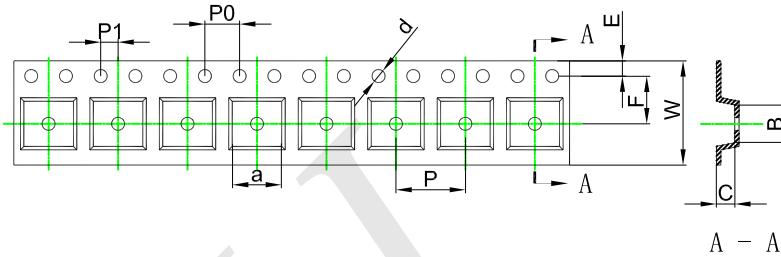

Packaging Description:

SOP8 parts are shipped in tape. The carrier tape is made from a dissipative (carbon filled) polycarbonate resin. The cover tape is a multilayer film (Heat Activated Adhesive in nature) primarily composed of polyester film, adhesive layer, sealant, and anti-static sprayed agent. These reeled parts in standard option are shipped with 2,500 units per 13" or 33cm diameter reel. The reels are clear in color and is made of polystyrene plastic (anti-static coated).
ALL DIM IN mm

Dimensions are in millimeter										
Pkg type	a	B	C	d	E	F	P0	P	P1	W
SOP8	6.40	5.40	2.10	Ø1.50	1.75	5.50	4.00	8.00	2.00	12.00

SOP8 Tape Leader and Trailer

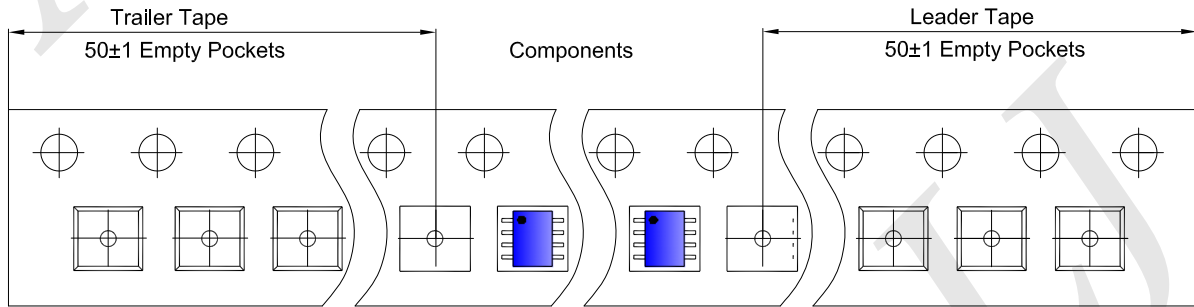

SOP8 Reel

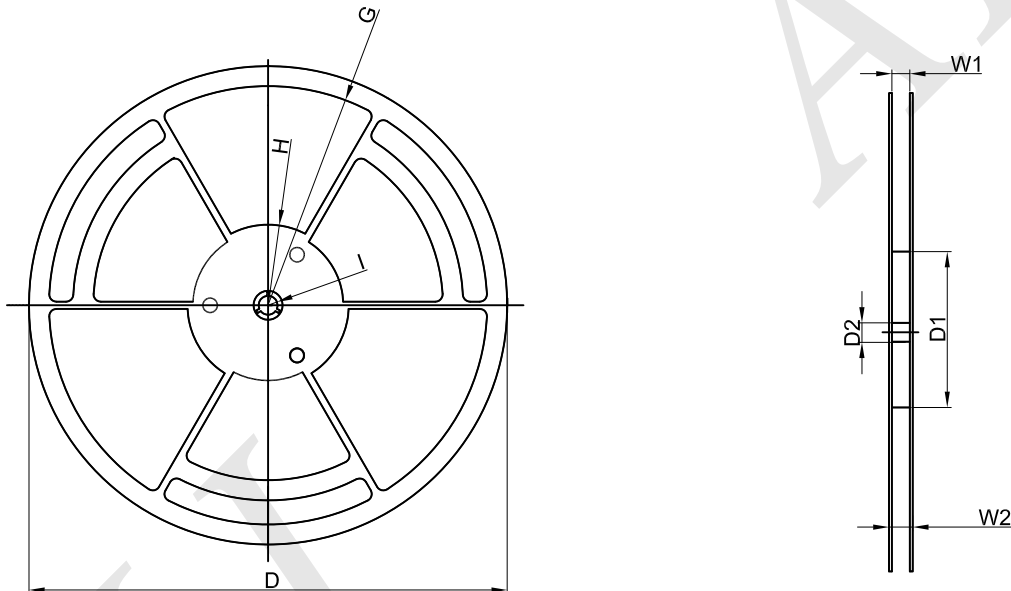

Dimensions are in millimeter								
Reel Option	D	D1	D2	G	H	I	W1	W2
13" Dia	Ø330.00	100.00	13.00	R151.00	R56.00	R6.50	12.40	17.60

REEL	Reel Size	Box	Box Size(mm)	Carton	Carton Size(mm)	G.W.(kg)
4,000 pcs	13 inch	8,000 pcs	360×360×65	64,000 pcs	565×380×390	

Soldering Parameters

Reflow Condition		Pb – Free assembly
Pre Heat	Temperature Min ($T_{S(min)}$)	150°C
	Temperature Max ($T_{S(max)}$)	200°C
	Time (min to max) (t_s)	60 – 190 secs
Average ramp up rate (Liquidus Temp) (T_L) to peak		5°C/second max
$T_{S(max)}$ to T_L — Ramp-up Rate		5°C/second max
Reflow	Temperature (T_L) (Liquidus)	217°C
	Temperature (t_L)	60 – 150 seconds
Peak Temperature (T_P)		260+0/-5 °C
Time within actual peak Temperature (t_p)		20 – 40 seconds
Ramp-down Rate		5°C/second max
Time 25°C to peak Temperature (T_P)		8 minutes Max.
Do not exceed		280°C

